

环保物料

产品型号	MODEL	KD-30S
材质&电镀	MATERIAL&PLATING	
螺丝	Screw	M3.0, 钢, 镀镍 Steel, Nickel Plated
端子	Terminal	黄铜, 0.8t 镀锡 Brass, Tin Plated
塑件	Housing	PA66, UL94V-0
电气性能	ELECTRICAL	
额定电压	Rated voltage	300V
额定电流	Rated current	20A
绝缘电阻	Insulation resistance	500MΩ/DC500V
耐电压	Withstanding voltage	AC2000V/1min
使用线径	Wire range	22-14AWG 2.5mm ²
机械性能	MECHANICAL	
温度范围	Temp. range	-40℃~+105℃
扭矩	Torque	0.5N.m 4.4Lb.in

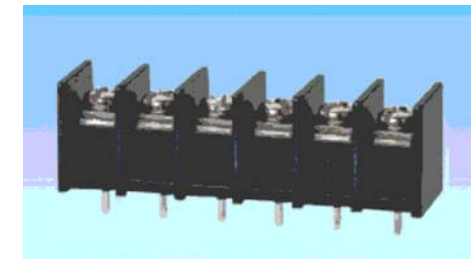
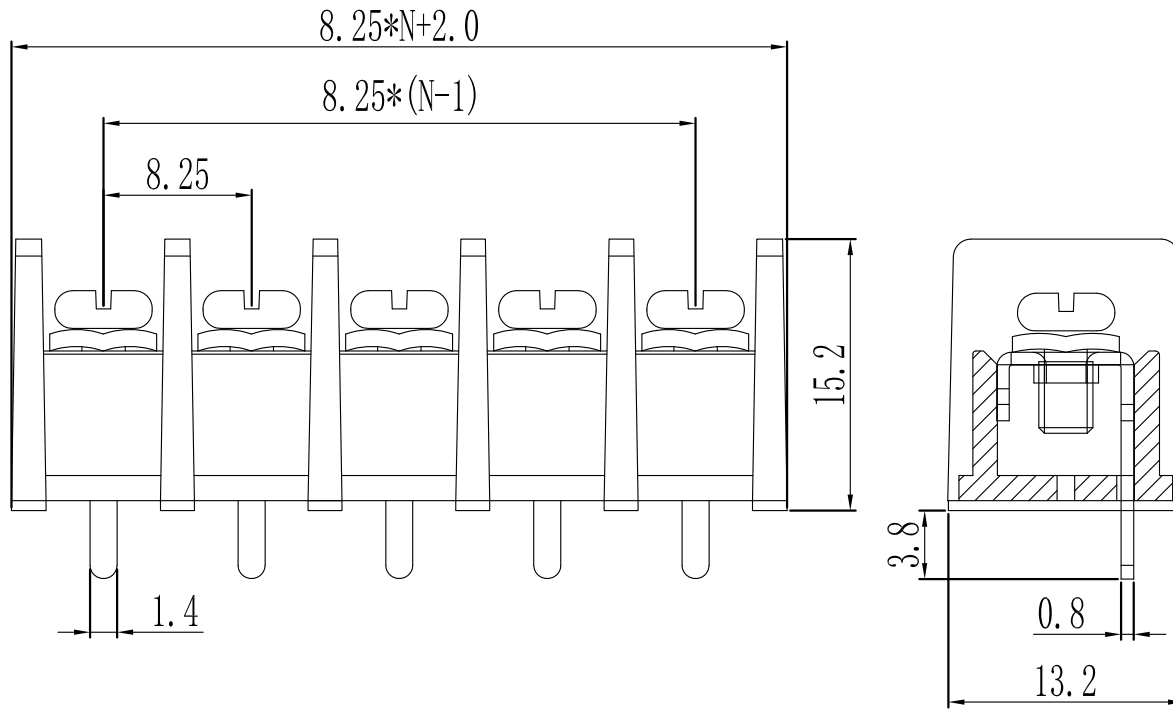

N=Number of Contacts

		GENERAL TOLERANCES		SCALE: 1:1	NAME	DATE	康导新能源 网址: www.dgoonne.com 电话: 0769-85337633 邮箱: 2850176886@qq.com 传真: 0769-85392827	PART. NO:	KDTB0204
		LINEAR	ANGLES	APPROVED	黎腾	2017.06.16		DWG. NO:	
A0	新图面发行	2017.06.16	UNIT: MM	0.00±0.25	X° ±3°	DESIGNER	肖坤权	2017.06.16	TITLE:
REV.	REVISION RECORD	DATE	SIZE: A4	0.000±0.15	X° X'±2°	DRAWN	旷淇	2017.06.16	Pitch8.25mm American/Japanese Terminal Blocks
								REV: A0	SHEET: 1/1